

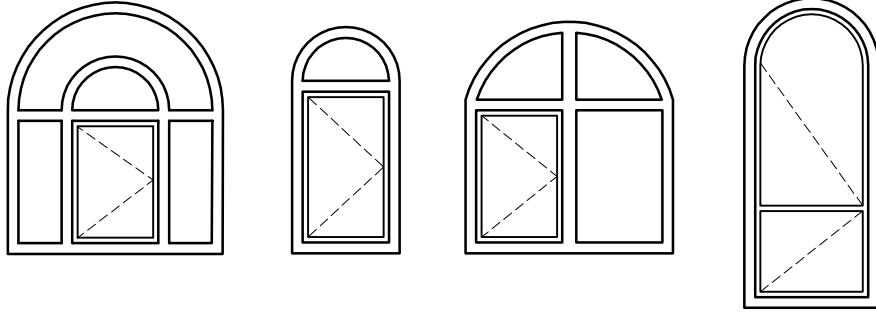



# KEMERLİ PENCERE BÜKÜM ÖLÇÜLERİ

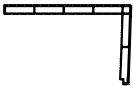

PROFİL ADI	KOMPLE BÜKÜM	KAYNAKLI BÜKÜM	BÜKÜM ÇAPMI MİN - MAX (mm)
 <ul style="list-style-type: none"> <li>• CAM ÜSTÜ YAPIŞTIRMA ÇITASI</li> <li>• KAPLAMALI CAM ÜSTÜ YAPIŞTIRMA ÇITASI</li> </ul>	X	X	600-1700
 <ul style="list-style-type: none"> <li>• PERVAZ PR. (80)</li> <li>• KAPLAMALI PERVAZ PR. (80)</li> </ul>		X	600-1700
 <ul style="list-style-type: none"> <li>• CON. ÇİFTCAM ÇITASI (14.0)</li> <li>• KAPLAMALI CON. ÇİFTCAM ÇITASI (14.0)</li> </ul>	X	X	600-1700
 <ul style="list-style-type: none"> <li>• CON. TEKCAM ÇITASI (27.0)</li> <li>• KAPLAMALI CON. TEKCAM ÇITASI (27.0)</li> </ul>	X	X	600-1700
 <ul style="list-style-type: none"> <li>• KASA - 55/3 PR.</li> <li>• KAPLAMALI KASA - 55/3 PR.</li> </ul>	X	X	600-1700
 <ul style="list-style-type: none"> <li>• KASA - 63/2 PR.</li> <li>• KAPLAMALI KASA - 63/2 PR.</li> </ul>	X	X	600-1700
 <ul style="list-style-type: none"> <li>• KASA - 63/3 PR.</li> <li>• KAPLAMALI KASA - 63/3 PR.</li> </ul>	X	X	600-1700
 <ul style="list-style-type: none"> <li>• ORTAKAYIT - 70/3 PR.</li> <li>• KAPLAMALI ORTAKAYIT - 70/3 PR.</li> </ul>	X	X	600-1700
 <ul style="list-style-type: none"> <li>• KASA - 55/3 / KANAT - 50/3 PR.</li> <li>• KAPLAMALI KASA - 55/3 / KANAT - 50/3 PR.</li> </ul>	X	X	650-1350
 <ul style="list-style-type: none"> <li>• KASA - 63/2 / KANAT - 56/2 PR.</li> <li>• KAPLAMALI KASA - 63/2 / KANAT - 56/2 PR.</li> </ul>	X	X	650-1350
 <ul style="list-style-type: none"> <li>• KASA - 63/3 / KANAT - 56/2 PR.</li> <li>• KAPLAMALI KASA - 63/3 / KANAT - 56/2 PR.</li> </ul>	X	X	650-1350

## KEMERLİ PENCERE İMALAT PRENSİPLERİ

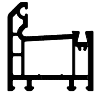
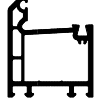
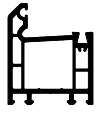
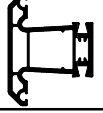
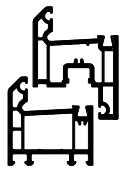
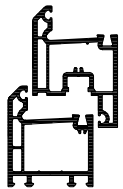
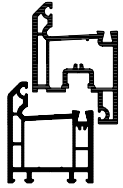
KOMPLE KEMERLİ PENCERE :

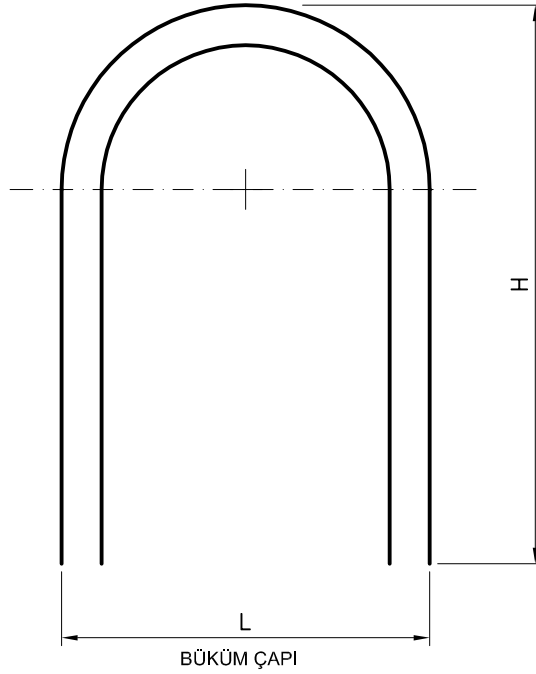
BÜKME BOYU :  $2H+L=5.5$  metreyi geçmemelidir.

KAYNAKLI KEMERLİ PENCERE :

