

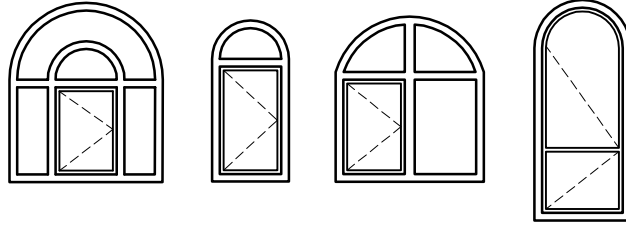



KEMERLİ PENCERE BÜKÜM ÖLÇÜLERİ

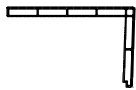

| PROFİL ADI | KOMPLE BÜKÜM | KAYNAKLI BÜKÜM | BÜKÜM ÇAPI MİN - MAX (mm) |
|--|--------------|----------------|------------------------------|
|  • CAM ÜSTÜ YAPIŞTIRMA ÇİTASI | X | X | 600-1700 |
|  • PERVAZ PR. (80) | | X | 600-1700 |
|  • CON. ÇİFTCAM ÇİTASI (7.0) | X | X | 600-1700 |
|  • CON. TEKCAM ÇİTASI (22.5) | X | X | 600-1700 |
|  • KASA - 56 PR. | X | X | 600-1700 |
|  • KASA - 57 PR. | X | X | 600-1700 |
|  • BİNİLİ KASA - 72 PR. | X | X | 600-1700 |
|  • ORTAKAYIT - 67 PR. | X | X | 520-1800 |
|  • KASA - 56 / KANAT - 45 PR. | | X | 650-1100 |
|  • KASA - 57 / KANAT - 55 PR. | X | X | 650-1350 |
|  • ORTAKAYIT - 67 PR. /KANAT - 55 PR. | X | X | 650-1350 |
|  • BİNİLİ KASA - 72 PR. /KANAT - 55 PR. | X | X | 650-1350 |

KEMERLİ PENCERE İMALAT PRENSİPLERİ

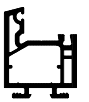
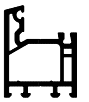
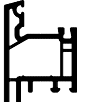
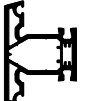
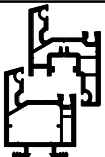
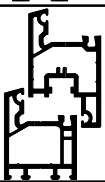
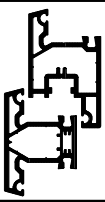
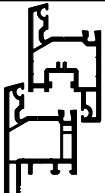
KOMPLE KEMERLİ PENCERE :

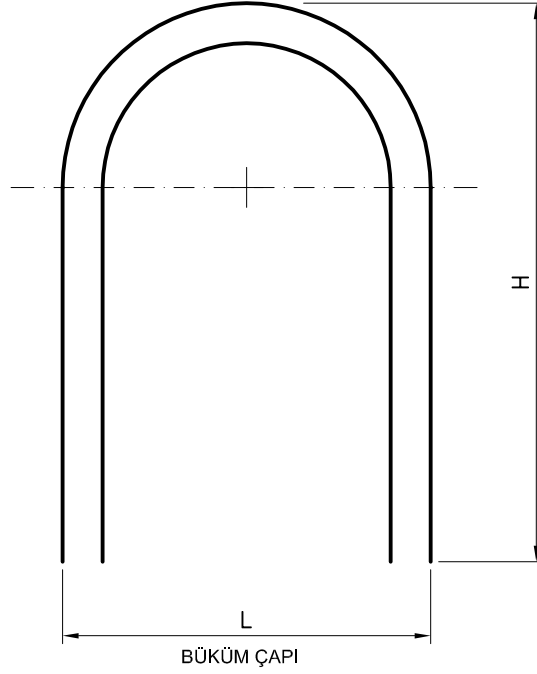
BÜKME BOYU : $2H+L=5.5$ metreyi geçmemelidir.

KAYNAKLI KEMERLİ PENCERE :

